

MT503CP-ISO

GUM Shower Range 15mm Thermostatic Mixing Valve with Isolation



Specification

Style:	Utility
Finish/Colour:	Chrome
Main Construction Material:	Brass
No of Controls:	1
Shower Type:	Thermostatic mixing
Maximum Hot Water Supply Temperature °C:	80
Dynamic Pressure Range: (bar)	5
Maximum Static Pressure: (bar)	10
Plumbing System Suitability:	All preferably balanced
Working Pressure Range:	Min. 0.1 - Max. 2.0 bar
Connection Inlet:	15mm
Connection Outlet:	15mm
Isolation Valve Included:	Yes
Check Valve Included:	Yes

Features:

- Isolation at mixing point facilitates easy servicing
- Automatic shutoff in the event of hot or cold water supply failure
- Check valves and serviceable filters as standard
- Operates at a maximum pressure differential of 10:1
- High pressure bath fill Part G compliant

Product Certifications:



Expiry: 31/10/2022
Certificate: 1710079



Expiry: 16/11/2022
Certificate: BC1860/1117



Expiry: 13/12/2022
Certificate: BC1861/1217

For more products, visit our website:
<http://www.bristan.com>

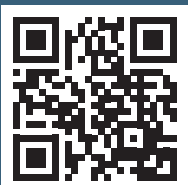

Dimensions (measurements in mm)

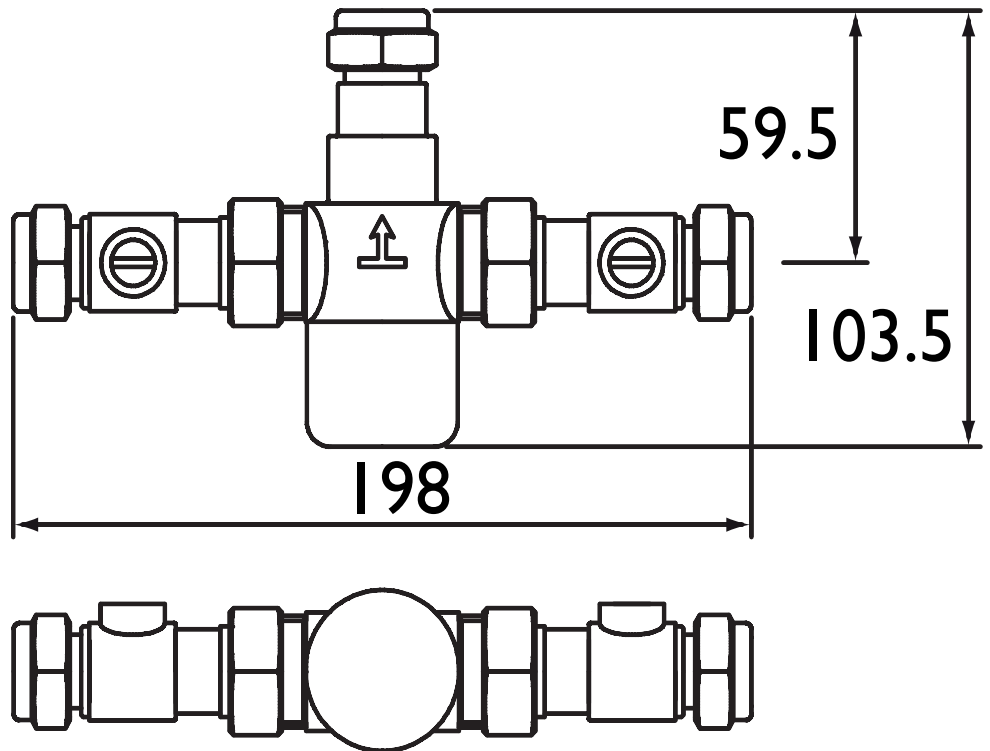

Flow Rates (l/min)

System Pressure (bar)	0.2	0.5	1	2
Open Mixed Outlet	8.5	15	21.5	31

TECHNICAL DATA SHEET



BRISTAN

TAPS & SHOWERS

D5