

Name	V-Fix Prime Frame
Collection	V8
Height (mm)	1120
Width (mm)	555
Depth (mm)	85
Designer	VitrA Design Team
Guarantee	10 year
Thickness	8 cm
Certificate	CE
Brand	VitrA
Installation Type	07
Mounting type	Pre-Wall
Recommended Minimum Pressure	Min:0.5-Max:10Recommended(1-5)

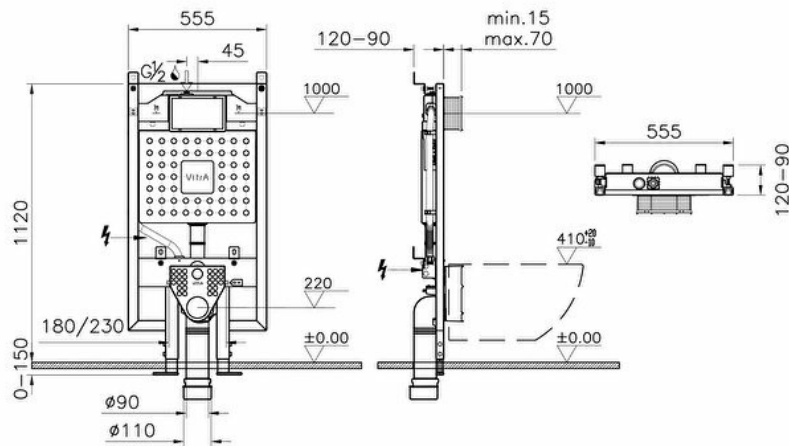

Product code: 768-5800-01

Description



All drawings contain the necessary measurements which are subject to standard tolerances.

For exact measurements, in particular for customized installation scenarios, it can only be taken from the finished ceramic product.