

# IRBS1-CP

## COMMERCIAL Tap Range Infrared Automatic Swan Basin Spout



### Features:

- Using non-touch controls they are operated with infrared technology.
- Bristan's automatic basin taps are great in supporting infection control measures.
- Mains or battery powered options.
- Automatic switch off supports water saving.
- A hard-wearing, flawless chrome finish that lasts for years. Scratch resistant and salt spray tested to ensure added durability.
- Can be used in a BREEAM assessed building.
- This tap outputs a fixed water temperature and should only be installed in conjunction with an approved thermostatic mixing valve to meet Part-G of the building regulations.

### Product Certifications:



WRAS Cert. Number: 1805363  
WRAS Expiry Date: 31/05/2023



For more products, visit our website:  
<http://www.bristan.com>



### Specification

<b>Product Type:</b>	Commercial Tap
<b>Main Construction Material:</b>	Brass
<b>Mount Type:</b>	Deck Mounted
<b>Connection Inlet:</b>	G 1/2" BSP
<b>Connection Outlet:</b>	Aerator
<b>Number of Tap Holes:</b>	1
<b>Valve/Cartridge Type:</b>	Solenoid Valve
<b>Plumbing System Requirements:</b>	Suitable for high pressure systems
<b>Minimum Dynamic Pressure:</b>	1.0 Bar
<b>Maximum Dynamic Pressure:</b>	5.0 Bar
<b>Maximum Hot Water Temperature: °C</b>	60
<b>Maximum Static Pressure: (bar)</b>	10
<b>Flow Type:</b>	Dual Flow
<b>Isolation Included:</b>	No

### Dimensions (measurements in mm)

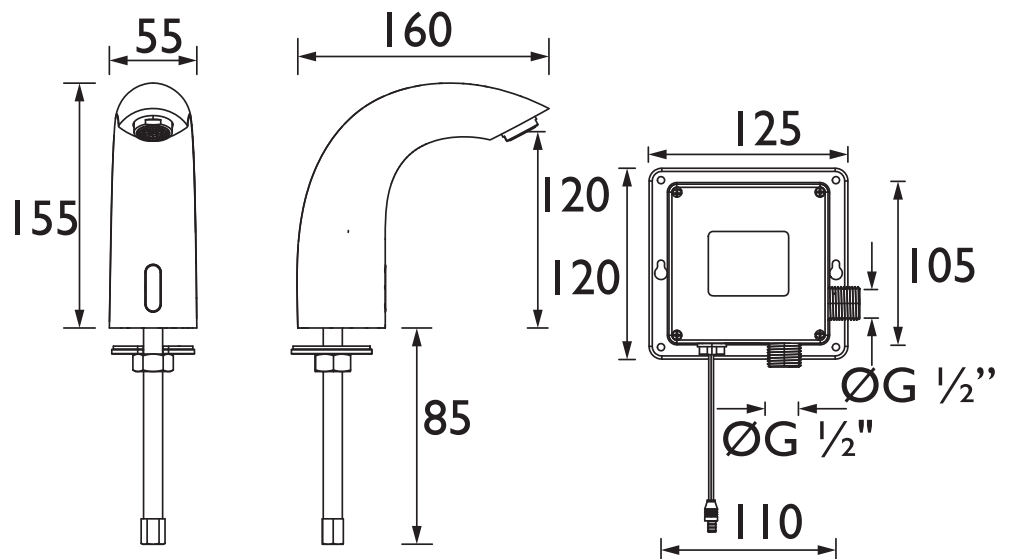

### Flow Rates (l/min)

System Pressure (bar)	1	2	3	5
IRBS1-CP	3.9	5	5	5

TECHNICAL  
DATA  
SHEET



**BRISTAN**

D9